

# Alternatives In Iron

A Division Of  
**HALLMAN IRONworks**  
Since 1991

Arbours

Obelisks

Trellises

Gates

Garden Stakes

Planters

Baskets

Topiary

Garden Art



Candle Holders

Sconces

Chandeliers

Wine Racks

Pot Racks

CD, DVD Racks

Wall Art

Wall Shelves

Kitchen &

Bathroom Accents

Hand  Crafted

**2014 Catalogue**  
Including Charity's Metal Art

Decorative Iron Accents for the Home & Garden, from Classic to whimsical design, with custom creations available.



#### DEFINITION...

Wrought iron was originally the type of steel used by blacksmiths and now is the finished piece itself.

The description “wrought iron” now applies to just about anything that is made out of metal. Unfortunately that includes products that are of tubular construction and mass produced.

Wrought iron is in reality steel that has been individually manipulated through heating, hammering, bending and welding, often with curls used as the most popular ornament.

#### SO WHAT’S THE DIFFERENCE BETWEEN WROUGHT AND CAST?

Wrought iron is steel that has been bent, not cast.

Cast iron is molten iron that has been poured into a mold to produce a desired ornament. Mass-produced, it often uses vines, flowers, leaves, and intricate designs. A seam shows where the two halves of the mold are joined together. Most finials [ornamental spear tops etc. used in fence posts and curtain rod ends] are also cast.

#### CHOOSING BETWEEN WROUGHT AND CAST...

This is a matter of personal taste and appreciation. If you do not mind mass-produced items and like ornate designs, cast iron may be the choice to make. If you prefer a unique, individually made piece, wrought iron may be what you’re looking for. There is always the option of combining the two for an interesting piece just as is used in old fashioned fencing or garden trellis.

#### WILL IT RUST?

Most of our pieces are sealed with a rust-inhibitive finish allowing it to be used indoors or out; however, our clear sealant may eventually allow rusting to occur. Our Natural finish is just that - natural steel and we guarantee that it will rust.

#### IS THERE ANY MAINTENANCE?

Iron is a natural, durable and recyclable material, able to withstand knocks, spills and everyday accidents. Our finish, like any other paint, will withstand reasonable amounts of wear... should a nick or scratch occur, gently rub area with fine sand paper or steel wool and lightly apply a matching paint, clear sealant or protective coating of mineral oil.

The same technique can apply to dealing with rust, should it occur.

#### WHAT GOES WITH WROUGHT IRON?

You may think we’re biased... but we believe anything. Iron can be combined with any wood, glass, fabric or colour.

The choice of fabric and pattern merely depend on the styling of the piece... whether its lines are clean or ornate. The same holds true of choosing glass, wood, marble, granite or tile for table tops or rack shelving.

No matter what style a home is, wrought iron can complement its décor.



# Table of Contents



All about Us.....	48
Angels.....	46, 47
Arbours.....	36 - 39
Baskets & Planters, etc.....	25
Bathroom Accents.....	12, 13
Benches.....	45
Brackets.....	16
Candelabra, Chandeliers & Sconces.....	4 - 7
CD & DVD Rackware.....	17
Christmas & Other Seasonals.....	46, 47
Coat Racks.....	12
Easel.....	14
Garden Stakes.....	28
Gates & Inserts.....	44
Hooks.....	22, 23
Magazine Rack.....	17
Map.....	49
Obelisks.....	31 - 35
Plant Stands, Planters & Baskets.....	23 - 27
Pot Racks.....	10, 11
Quilt Racks.....	14
Shelves.....	15
Swivel Backs.....	23
Tables & Tripods.....	24
Tapestry Rods.....	14
Topiary.....	29 - 31
Towel Bars, Coat Racks & Such.....	12, 13
Trellises.....	40 - 43
Wall Art.....	18 - 21
Wine Racks.....	8, 9

## 🌀 Catalogue Tips

### Colours Available

Black. Br.Stl = Brushed Steel = clear lacquer. Natrl = Natural

Antq.Stl = Antique Steel [clear lacquer with black over wash]

*Please note that we are using one of the most durable paints for metal on the market and trust it to hold up as much in the future as it has in the past [16 years to date!]*

### Measurements

OD = Outside dimensions ID = Inside Dimensions Approx. = Approximate

H = Height W = Width [side to side] Dp = Depth [front to back] Dm = Diameter [across on Diagonal]

Dm.Base = Diameter of base for largest measurement. Sq. = Square Rnd = Round

### Other

T = Taper Candle Cup P = Pillar Candle Cup P2 = Pillar Cup with Peg for Candles

V = Votive Ring Hks = Hooks

Based on a 17th century candle...

When a suitor came courting, the visit's length was determined by how much of the candle was wound up above the coil to burn. Since most candles were hand crafted at home, Mother had the ability to make some candles burn faster than others!

A standard taper candle will fit inside the coil. We do, however, recommend using a high quality dripless candle.

Please remember to burn your candle turned above the coil.

Suitor not required!

CANDLE NOT INCLUDED.



\$19.50

#101  
Courting Candle, Simple  
Approx. 10"H x 13"W  
Black, Br.Stl or Natrl



\$21.50

#102  
Courting Candle, Heart  
Approx. 10"H x 13"W  
Black, Br.Stl or Natrl



\$30.00

#103  
Loving Heart Courting Candle  
Approx. 11"H x 6"W x 8"Dp  
Black, Br.Stl or Natrl  
*Sits or Hangs*



\$29.00

#1040  
Courting Candle, Romance  
Approx. 13"H x 9"W  
Black, Br.Stl or Natrl  
*In loving memory of Tina.*



\$33.00

#1010  
Together Courting Candle  
Approx. 10"H x 15-1/2"W x 10"Dp  
Black, Br. Stl or Natrl

This Courting Candle symbolizes the joy of being together.



\$16.50

#068-601  
Courting Candle,  
Garden Style Back  
Approx. 12"H x 7"W  
Black, Br.Stl or Natrl

*Also Available with other Backs  
see our Swivel Back page*



For setting the mood, softer lighting or just because, our candle chandeliers will add atmosphere to any setting or for outdoor use.



#140, Classic  
4 Arm, 1 Tier

#131, Classic  
6 Arm, 1 Tier

#132, Classic  
8 Arm, 1 Tier

#130, Classic  
12 Arm, 2 Tier

#139, Classic  
9 Arm, 2 Tier

Classic Chandeliers  
Approx. 26"H x 24"Dm  
All are available in T / P / P2 / V  
Available in Black, Br.Steel, Antq.Stl or Natrl



#134, Ring Style  
6 Arm, Approx. 22"Dm  
Black, Br.Stl Antq.Stl or Natrl  
Also in: P / T / V.  
Comes with 1 6-8" ext. hook



Contemporary Single Tier Chandelier  
#143-4, 4 Arm  
#143-6, 6 Arm [shown] \$95.00  
Approx. 24"H x 26"Dm  
P / T.  
Black, Br.Stl or Natrl



Single Tier Victorian Scroll  
#144-4, 4 Arm  
#144-6, 6 Arm \$117.00  
Approx. 24"H x 26"Dm  
P / T.  
Black, Br.Stl or Natrl



#140-4 \$47.00  
Mini Chandelier /Candelabra  
Approx. 23"H x 12"Dm  
Black, Br.Stl or Natrl  
**Taper ONLY, 1 Hook ONLY**



Unless otherwise stated, all chandeliers come with 2 extension hooks. Approx. 10-12"L



T = Taper, P = Pillar  
P2 = Pillar with Peg  
V = Votive



#144-6

Whether to fill and empty space, decoratively flank an existing anything [mirror...] or to use as mood lighting, our candle sconces will compliment many decors.



**\$28.00**

#137  
Simple Triangle Sconce PAIR  
Approx. 13"H x 6"W x 5"Dp  
TAPER ONLY  
Black, Br.Stl or Natural  
[shown on angle]



**\$34.00**

#138-4  
Arch Sconce PAIR  
Approx.  
10"H x 6"Dp  
P / P2 / T  
Black, Br.Stl  
or Natural



**\$34.00**

#138-5  
Finial Tail Sconce PAIR  
Approx. 9"H x 7"Dp  
P / P2 / T  
Black, Br.Stl or Natural

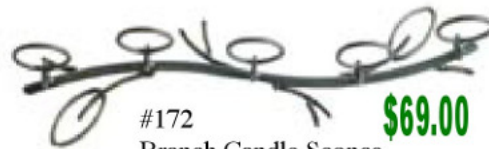

#172 **\$69.00**  
Branch Candle Sconce  
Approx. 22"L x 5.5"H x 4"Dp  
P / P2 / T / V  
Natural, Br. Steel or Black



**\$70.00**

#174  
Candle Sconce Set, 5 pieces.  
Approx. 6"L - each Diamond side  
T / P / P2 / V  
Black, Br.stl or Natrl



**\$38.00**

**\$35.00**

**\$30.00**

**Wave Stem Candle Sconces**

These funky yet simple sconces have matching accents throughout our catalogue. Check out our candelabra and rackware pages.

#167-1, SM - Approx. 12"L  
#167-2, MD - Approx. 21"L  
#167-3, LR - Approx. 27"L  
#167-123, Set of 3 = 1 of each  
P / P2 / T **\$93.00**  
Black, Br.Stl or Natural



**Scroll Candle Sconces**

Simple Scroll PAIRS  
#175-1, Sm. Approx. 16"L **\$64.00**  
#175-2, Md. Approx. 30"L **\$70.00**  
#175-3, Lr. Approx. 42"L **\$82.00**  
P / P2 / T  
Black, Br.Stl or Natural

With Collar PAIRS  
#177-1, Sm. Approx. 16"L **\$70.00**  
#177-2, Md. Approx. 30"L **\$82.00**  
#177-3, Lr. Approx. 42"L **\$101.00**  
P / P2 / T  
Black, Br.Stl or Natural



**\$29.00**

#291  
Angel Pillar Holder  
13-1/2"H x 7"Dp  
Hang or stand - it does both!  
P / P2  
Br.Stl or Natrl ONLY

*All our wall sconce are designed with safety in mind as much as attractiveness.*

*We've set our candle cups to be no less than 3" fom the wall at the center of the holder.*

**TIP:** *The pillar cups without pins can also be used to display 4" potted plants! A little adhesive and there you go!*

T = Taper, P = Pillar  
P2 = Pillar with Peg  
V = Votive



#125 **\$29.00**  
Reg. Scroll Candle Holder  
Approx. 11"H x 8"Dm  
P / P2 ONLY  
Black, Br.Stl or Natural

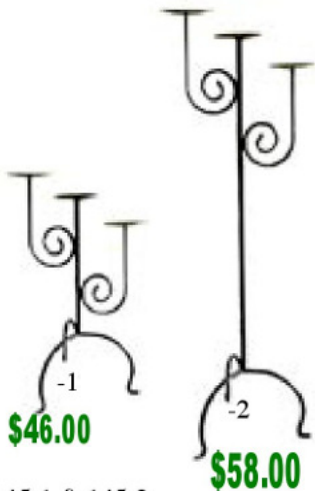

#145-1 & 145-2  
Staggered Scroll Candelabra  
#145-1, Approx. 24"H  
#145-2, Approx. 48"H x 20"Dm  
P / P2 / T  
Black, Br.Stl or Natural



#145-3 & 145-4  
Arch Arm Candelabra  
#145-3, Approx. 24"H  
#145-4, Approx. 48"H x 20"Dm  
P / P2 / T  
Black, Br.Stl or Natural



#146  
3 Scroll Candelabra  
Approx. 36"H x 20"Dm  
P / P2 / T  
Black, Br.Stl or Natural



Wave Stem Candle Holders  
#147-1, SM - Approx. 22"H  
#147-2, MD - Approx. 28"H  
#147-3, LR - Approx. 34"H  
#147-123,  
Set of 3 [1 of each size]  
P / P2 / T **\$104.00**  
Black, Br.Stl or Natural



#445-4



T-Light Pets  
#445-4, Cat  
#446-4, Pup  
Approx. 23"H x 13"Dm  
Br.Stl or Natrl ONLY



#446-4  
**\$47.00**

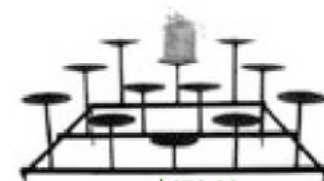

#155  
12 PILLAR Candle Stand  
Approx. 16"H x 24-1/2"W x 16"Dp  
P / P2 ONLY  
Black, Br.Stl or Natural  
*Looks great on a console table or  
place in the fireplace over an empty  
log grate.*

**\$176.00**



#156  
Mantel Candelabra  
Approx. 16"W x 8"H x 5"Dp  
P / P2 / T  
Black, Br.Stl or Natural

**\$52.00**



#292  
Angel Candelabra  
Approx. 36"H x 12"Dm  
P / P2 / T / V  
Br.Stl or Natrl  
*NOTE: the Lady has  
new wings,  
see #449-5*

**\$47.00**



#4490  
Garden Fairy  
Approx. 34"H x 14"Dm  
P / P2 / V  
Br.Stl or Natrl

**\$49.00**



#151T #151P  
#151  
LR Candle Tree  
Approx. 36"H x 20"Dm  
P / P2 / T  
Black, Br.Stl or Natural

**\$81.00**

T = Taper, P = Pillar  
P2 = Pillar with Peg  
V = Votive



#252 **\$58.00**  
4-bottle/ glass  
Party Rack!  
Approx. 24"H x 10"Dm  
Black, Br.Stl, Natrl



#254 **\$58.00**  
Hanging 8-bottle  
Wine Rack  
Approx. 26"L x 7"Dm  
Black, Br.Stl, Natrl



#257 **\$69.00**  
8-bottle Wine Rack  
Approx. 36"H x 19"Dm  
Black, Br.Stl, Natrl



#270 & 270-5 **\$81.00**  
10-bottle Wine Racks  
#270, Straight, #270-5 Curve  
Approx. 40"H x 19"Dm  
Black, Br.Stl, Natrl  
*Both come with Finial or Ring, please  
specify*



**\$82.00**



#267 **\$35.00**  
4-bottle Wall Wine Rack  
Approx. 22"L x 8"W x 4-1/2"Dp  
Black, Br.Stl, Natrl  
*This Rack has other uses  
check out pg.19*

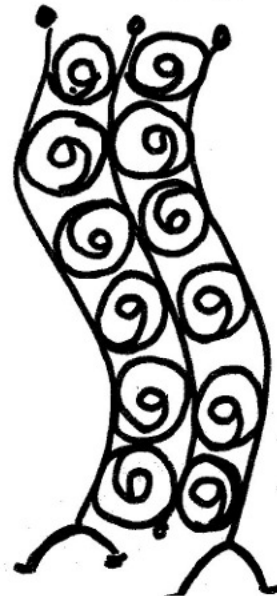

#269-1  
12 Bottle Funky Curve  
Wine Rack  
Approx.  
40"H x 11"W-base  
Black, Br.Stl, Natrl  
**\$117.00**



#279-1  
Glass Rack, Hanging  
Holds 4  
Approx.  
Black, Br.Stl, Natrl



#252-1 **\$41.00**  
Glass Rack, Standing  
Holds 4 glasses + 1 bottle!  
Approx.  
Black, Br.Stl, Natrl



#279-2 **\$46.00**  
Glass Rack, Wall  
Holds 6  
Approx.  
Black, Br.Stl, Natrl





**\$35.00**

#411-1  
Funky Bug Bottle Holder  
Approx. 11"H x 16"W x 10"Dp  
Brushed Steel or Natural ONLY  
*Finally a truly useful bug you won't mind at your table!*



**\$18.00**

#251-1  
Simple Wine Bottle Holder  
Approx. 5"H x 7"L  
Black, Br.Stl, Natrl



**\$20.00**

#251-2  
Spiral Base Wine Bottle Holder  
Approx. 5"H x 7"L  
Black, Br.Stl, Natrl



**\$14.00**

#230-5  
Single Bottle Hanger  
for Pot Racks

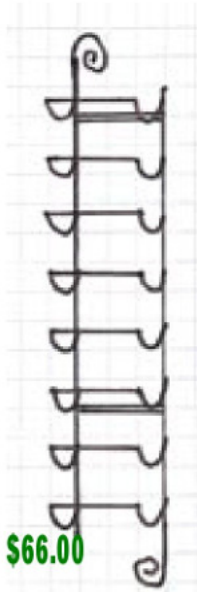

**\$66.00**

#268-10  
10-bottle  
Wall Rack  
Approx. 50"L x 7"W  
Black, Br.Stl, Natrl



**\$189.00**

#260-1  
24 Bottle Horizontal Wine Rack  
Approx. 30"L x 24"H  
Black, Br.Stl, Natrl

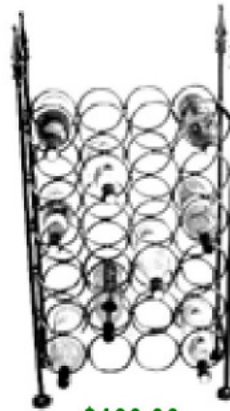

**\$189.00**

#260-2  
24 Bottle Vertical Wine Rack  
Approx. 20"W x 36"H  
Black, Br.Stl, Natrl

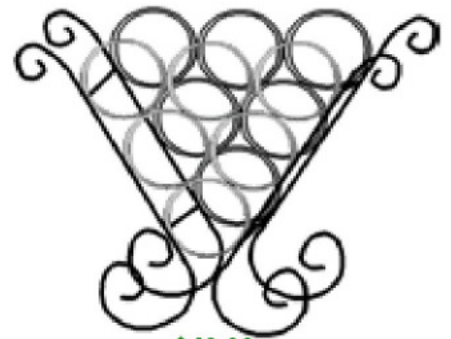

**\$48.00**

#265-5  
6 Bottle Wine Rack  
Approx. 20"H x 14"W  
Black, Br.Stl or Natrl

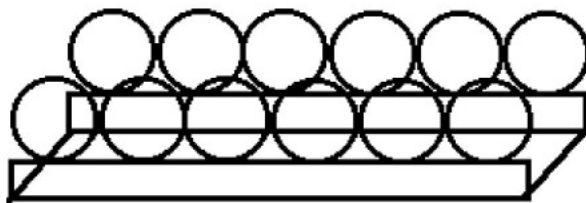

#265-61  
6-bottle Cupboard /Counter Rack  
Approx. 26"L x 7"H x 7"Dp **\$48.00**  
Black, Br.Stl or Natural



#257

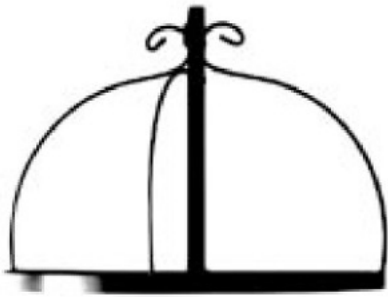

#220 **\$93.00**  
1/2 Crown Pot Rack  
Approx. 22"W x 18"H x 7"Dp, 5 Hks  
Black, Br.Stl or Natrl



#220-1 **\$81.00**  
1/2 Crown Pot Rack  
Approx. 22"W x 18"H x 7"Dp, 6 Hks  
Black, Br.Stl or Natrl



#220-4 **\$81.00**  
Rectangular Wall Pot Rack  
Approx. 22"W x 18"H x 7"Dp, 6 Hks  
Black, Br.Stl or Natrl



#221 **\$123.00**  
Full Crown Pot Rack  
Approx. 22"Dm x 20"H, 8 Hks  
Black, Br.Stl or Natrl



#221-5 **\$117.00**  
Full Crown Ceiling Hugger Pot Rack  
Approx. 22"Dm x 20"H, 8 Hks  
Black, Br.Stl or Natrl



#221-7 **\$89.00**  
Full Crown Pot Rack  
Approx 14"Dm x 16"H, 4 Hks  
Black, Br.Stl or Natrl  
Works great for stainless utensils,  
easier to find that spatula!



#223-1



#231  
Pot Hooks  
Sold seperately or in sets of  
4 [-4], 5 [-5], or 6 [-6].  
Black ONLY

**\$9.00**



#224-5  
Scroll Basket Wall Pot Rack  
Approx. 24"W x 9"H  
Black, Br.Stl or Natrl

**\$106.00**





**\$152.00**

#225  
Rectangular Grid Pot Rack  
Approx. 24"L x 16"W, 10 Hks  
Black, Br.Stl or Natrl



**\$81.00**

#226  
Ladder Style Pot Rack  
Approx. 30"L x 18"W, 8 Hks  
Black, Br.Stl or Natrl



**\$93.00**

#228  
Simple Ring Pot Rack  
Approx 22"Dm, 10 Hks  
Black, Br.Stl or Natrl

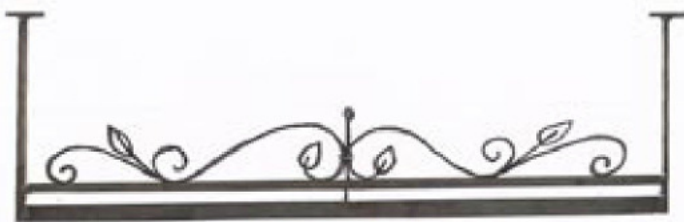

**\$118.00**

#222-2  
Garden Style Pot Rack  
Approx. 32"L x 12"H, 6 Hks  
Black, Br.Stl or Natrl



#230-5  
Single Wine Bottle Hanger  
Black, Br.Stl or Natrl **\$14.00**

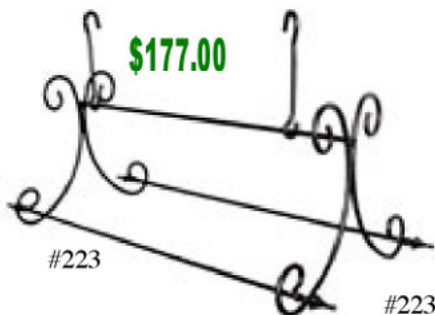

**\$177.00**

#223

#229  
Race Track Ceiling Hugger  
Pot Rack  
#229-1,  
Drop Down Version

Approx. 30"L x 12"W x 12"H,  
+ 12 Hks  
Black, Br.Stl or Natrl



#229

**\$189.00**

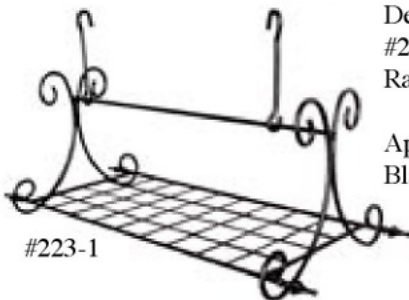

#223-1

#223  
Decra Scroll Pot Rack  
#223-1  
Rack with Grid  
Approx. 36"L x 18"W, + 12 Hks  
Black, Br.Stl or Natrl

**\$225.00**



#229-1

**\$177.00**



Tie Backs/ Multi-use Hooks  
 #286-1: Country Heart, #286-2: Garden Style,  
 #286-5: Spear Heads  
 Sold in PAIRS, Approx. 4" x 3"  
 #558-5 Garden Style Branch Hook,  
 Approx. 10"H x 5"W x 3"Dp  
 Sold as single piece  
 Black, Br.Stl or Natrl

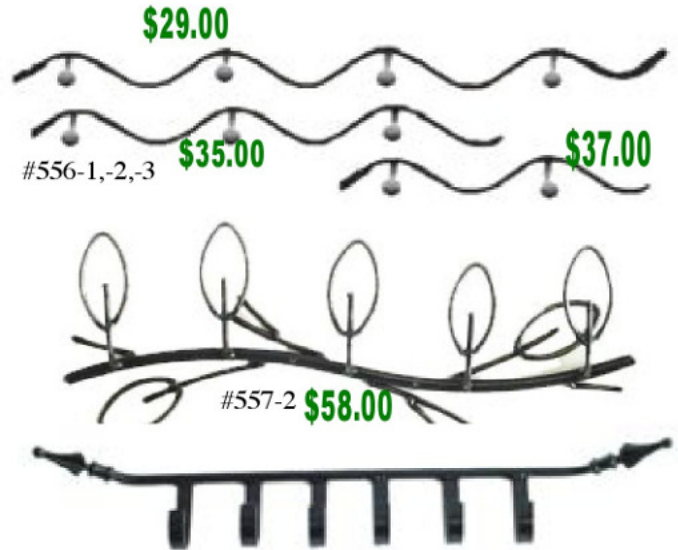

Wall Coat Racks  
 #556-1: SM - Approx. 12"L, #556-2: MD - Approx. 21"L  
 #556-3: LR - Approx. 27"L #556-123, set of 3  
 #557-2, Garden Style Approx. 22"L x 7"H x 3"Dp  
 #557-5, Spear End Style: Approx. 30"L x 4-1/4"H x 3"Dp  
 Black, Br.Stl or Natrl



Towel Bars  
 #559: Simple Scroll, Approx. 28"L  
 #559-5: Spear End Style,  
 Approx. 30"W x 5-1/2H x 3-1/2Dp  
 Black, Br.Stl or Natrl



Towel Bars  
 #559-2: Garden Style, Approx. 22"OD/ 16"Bar  
 #559-7 Fish Pond,  
 Approx. [xx]": x [xx]"H x [xx]"Dp  
 Black, Br.Stl or Natrl  
 This collection will be finding a place in my bathroom asap!



#559-20



#559-70  
 Fish Pond Towel Ring  
 Approx. 10"W + 6"Ring  
 Black, Br.Stl or Natrl



Paper Towel Holders  
 #561, Smle Scroll  
 #561-2, Garden Style  
 #561-5, Spear Ends  
 #561-7, Fish Pond  
 Black, Br.Stl r Natural



#561-50  
 Vertical Paper Towel  
 Holder, Spear Top  
 Approx. 16"H x 4-1/2"Dm  
 Black, Br.Stl or Natural



T-Paper Holders  
 #560, Simple Scroll  
 #560-2, Garden Style  
 #560-5, Spear Ends  
 #560-7, Fish Pond  
 Black, Br.Stl, Natural

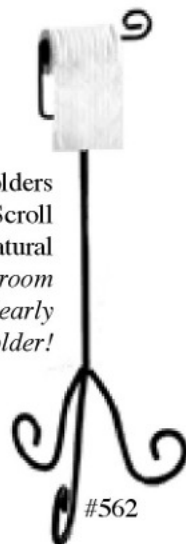

Standing T-Paper Holders  
 #562, Simple Scroll  
 Black, Br.Stl or Natural  
*Excellent for a cottage or those bathroom  
 where the builder wasn't thinking clearly  
 when he put in the t-paper holder!*



Standing T-Paper Holder  
 #562-2, Garden Style  
 Black, Br.Stl or Natural  
*Charity's uses the back leaf rod to store  
 extra rolls of t-paper!*



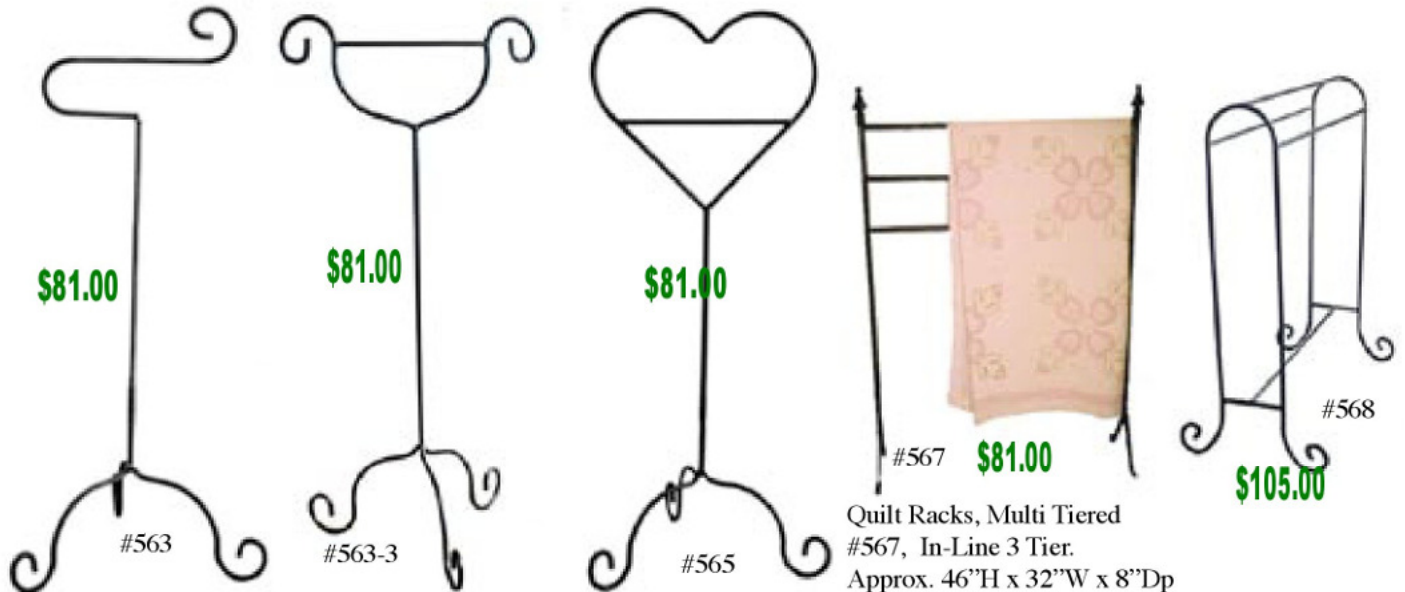

Quilt Stands

- #563, Simple Scroll Style, Approx. 48"H x 21"Dm Base
- #563-3, Lyre Style, Approx. 48"H x 21"Dm Base
- #565, Heart Style, Approx. 50"H x 21"DM Base

Black, Br.Stl or Natural

*Our Heart Quilt Holder doubles as one of the best bedroom buddies around. Just hang a shirt, blouse and/or jacket over the heart and slacks or jeans over the rung... clothes pins can do the trick for skirts.*

Quilt Racks, Multi Tiered

- #567, In-Line 3 Tier. Approx. 46"H x 32"W x 8"Dp
- #568, 2 Ter Triple Rung. Approx. 45"H x 35"W x 12"Dp

Black, Br.Stl or Natrl

*#567 stands in our bedroom and neatly holds extra blankets a pair of jeans and a hat or two... sometimes my purse!*



#553-3

Picture Rack, Holds 3

- Approx. "H x "W x "Dp

Black, Br.Stl or Natrl

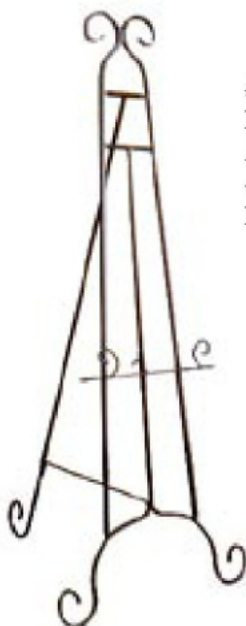

#570

Large Easel

- Approx. 58"H x 26"Dp/ open + Adjustable Arm at 22"H

Black, Br.Stl or Natrl

\$261.00



#570-2

see #570-1 for info

\$226.00



#570-5

Mini Table Easel

- Approx. 9"H x 11"H x 5"Dp [6"W-arm]

Black, Br.Stl or Natrl

\$27.00



**\$57.00**

#301  
Single Tier Wall Shelf  
Approx. 16"H x 21-1/2"W x 9"Dp  
Black, Br.Stl or Natural



**\$62.00**

#301-6  
Single Tier Wall Shelf  
with Towel Bar, Spear Design  
Approx. 16"H x 21-1/2"W x 9"Dp  
Black, Br.Stl or Natural



**\$66.00**

#301-7  
Single Tier Garden Pond Wall Shelf  
Approx. 16"H x 21-1/2"W x 9"Dp  
Black, Br.Stl or Natural



**\$80.00**

#302  
2 Tier Wall Shelf  
Scroll Design  
Approx. 16"H x 21-1/2"W x 9"Dp  
Black, Br.Stl or Natural



**\$84.00**

#302-9  
2 Tier Media Shelf, Stands or Hangs  
Approx. 16"H x 21-1/2"W x 9"Dp  
Black, Br.Stl or Natural  
*I have this shelf on my night stands to allow a little extra storage - and the kleenex box at the ready!*



#302-1  
2 Tier Scroll Corner Wall Shelf  
Approx. 24"H x 12"W x 10"Dp  
Black, Br.Stl or Natural

**\$105.00**

#303  
3 Tier Wall Shelf  
Approx. 27-1/2"H x 21-1/2"W  
x 7-1/4" & 9"Dp  
Black, Br.Stl or Natural



**\$102.00**



#087, **\$36.00**  
 #087, C-Scroll Bracket PAIR  
 Approx. 8" x 10" - Reversible  
 Black, Br.Stl or Natural



#087-1, **\$34.00**  
 #087-1, Scroll Tip Bracket PAIR  
 Approx. 8" x 10" - Reversible  
 Black, Br.Stl or Natural



#087-2, **\$46.00**  
 #087-2, Garden Style Bracket PAIR  
 Approx. 8" x 10" - Reversible  
 Black, Br.Stl or Natural



#087-3, **\$36.00**  
 #087-3, Simple Scroll Bracket PAIR  
 Approx. 8" x 10" - Reversible  
 Black, Br.Stl or Natural



#088, **\$70.00**  
 #088, Spiral Top Scroll  
 Bracket PAIR  
 Approx. 8" x 10"  
 Black, Br.Stl or Natural



#087-91, **\$77.00**  
 #087-91 Heavy Duty Bracket, Pair  
 Approx. 10" x 12" - Reversible  
 Black, Br.Stl or Natural



We use #088 in various sizes to hold our surround sound speakers and a version of #087-91 to hold up our mantel.  
 We took out the fake fireplace, kept the beautiful mantel!



#283-2, **\$47.00 / 12"**



#283-3, **\$66.00 / 36"**

Tapestry Rod with Ends, attached anchors  
 #283-1 Finial Ends [see below]  
 #283-2 Garden Style  
 #283-3 Simple Ball Ends

-----  
 [ /12] 12"ID [ /20] 20"ID [ /36] 36"ID  
 BR1 = Arch Hooks, BR2 = Invisible Tight Anchors  
 BR3 = Invisible Extended Anchors  
 Black, Br.Stl or Natural  
 -X- Custom sizing available



#283-1



BR1

**\$13.00**



BR2

**\$16.00**



BR3

**\$16.00**





\$46.00

\$70.00

\$52.00

#241

#241-2

#242

#241, Single Column CD Rack  
 Approx. 53"H x 14"W & Dp, holds about 100 reg. CDs  
 #241-2, Double Column CD Rack  
 Approx. 53"H x 23"W x 14"Dp, holds about 100 reg. CDs  
 #242, Single column DVD Rack  
 Approx. 53"H x 14-1/2W x 14"Dp, holds about 72 single DVDs  
 Br.Stl or Natrl ONLY



\$81.00

#249  
 Curved Magazine Rack  
 Approx. 38"H x 15-1/4"W  
 x 16-1/2"DP [legs]  
 Black, Br.Stl or Natrl  
*We sell these a softern for towel racks.*



\$34.00

\$46.00

\$30.00

\$44.00

#243

#243-2

#244

#244-2

#243, SM. Single Column,  
 Approx. 29"H x 14"W & Dp  
 Holds about 50 reg. CDs  
 #243-2, SM Double Column  
 Approx. 29"H x 27"W x 14"Dp  
 Br.Stl or Natrl ONLY

#244, SM. Hanging Single Column  
 Approx. 24"H x 5-3/4"W  
 Holds about 50 reg. CDs  
 #244-2, SM. Hanging Double Column  
 Approx. 24"H x 11"W  
 Br.Stl or Natrl ONLY



\$69.00

#243-99  
 Speaker Stand CD Racks  
 Approx 30"H x 14"W & Dp  
 Speaker Support is 8" x 8"  
 Black, Br. Stl or Natrl  
*Designed to screw-mount speakers in place - OR - seperate the stands with a finished board for an instant console table..  
 Silicone a tile in place for a nice little plant stand!*



**\$46.00**

#451-1

#451-1, Wall Bouquet  
Approx. 24"H x 18"W  
#451-2 Bouquet with planter ring [approx. 5-3/4"ID]  
Black, Br.Stl or Natrl



#451-2  
**\$50.00**



**\$89.00**

#455-2

Scroll Wall Branch  
Apprx. 40"L x 21"W  
Black, Br.Stl, Natrl  
or Antq.Steel  
This piece can be hung on any  
angle.. How about from the  
ceiling for drying flowers...



**\$89.00**

#455-5

Magnolia Wall Branch  
Apprx. 24"L x 15"W  
Black, Br.Stl, Natrl  
or Antq.Steel

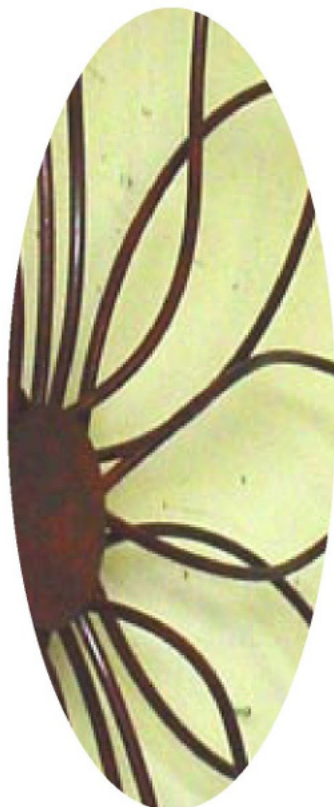

#4020-38



#452-3  
**\$35.00**  
Tulip Ring  
Approx. 12"Dm  
Br.Stl or Natrl ONLY



**\$148.00**

#451-71

Flower Basket Wall Art  
Approx. 24"H x 24"W x 2-3"Dp  
Black, Br.Stl or Natrl





#4020-28 **\$106.00**  
 Medium Wall Flower  
 Approx. 28"Dm  
 Black, Br.Stl or Natrl



#4020-38 **\$154.00**  
 Large Wall Flower  
 Approx. 38"Dm  
 Black, Br.Stl or Natrl



#464-1 **\$93.00**  
 Butterfly Wall Art  
 Comes with a choice of  
 P= Pillar, P2 = pillar + Peg  
 T=Taper, V=Votive,  
 PR= Planter Ring=5-3/4"ID  
 Black, Br.Steel or Natural



#452-1 **\$34.00**  
 Bullrush Ring Wall Art  
 Approx. 22"H x 19"W  
 Black, Br. Stl or Natrl



#453-1 **\$55.00**  
 Scrolling Arch Wall Art  
 Approx. ??"H x ??"W  
 Black, Br.Stl or Natrl



Sculpted Scroll  
 close up.



**\$154.00**

#461-91Sculpted Scroll Wall  
 Cross  
 Approx. 24"H x 16"W  
 Br.Stl or Natrl ONLY  
*Everyone in our family has  
 one!*



#462  
Kokopelli Pair **\$71.00**  
Babe = Approx. 25"H x 18"W  
Fella = Approx. 24"H x 12"W



#462-3 **\$68.00**  
Kokopelli Travellor  
Approx. 48"H x 20"W  
Black, Br.Stl or Natrl



#461-6 **\$59.00**  
Donna Dolphin  
Approx. 36"H x 24"W  
Br. Stl or Natrl ONLY



#463  
GoldFish Bowl **\$58.00**  
Approx. 18"H x 21"W  
Black, Br.Stl or Natrl  
*Finally - a fish bowl I only have to dust!*



#445-1  
Wall Cat  
Approx. 8"H x 21"W x 6-1/2"Dp  
Br. Stl or Natrl ONLY  
**\$52.00**



#446-1  
Wall Dog  
Approx. 28"H x 20"W x 6-1/2"Dp  
Br. Stl or Natrl ONLY  
**\$52.00**



#461-7 **\$67.00**  
Fergy Frog  
Approx. 36"W x 24"H  
Br. Stl or Natrl ONLY



#461-4 **\$57.00**  
Fanny Fantail  
Approx. 24"W x 26"H  
Br. Stl or Natrl ONLY



#461-8 **\$68.00**  
Sammy Spider  
Approx. 22"H x 30"W  
Br. Stl or Natrl ONLY

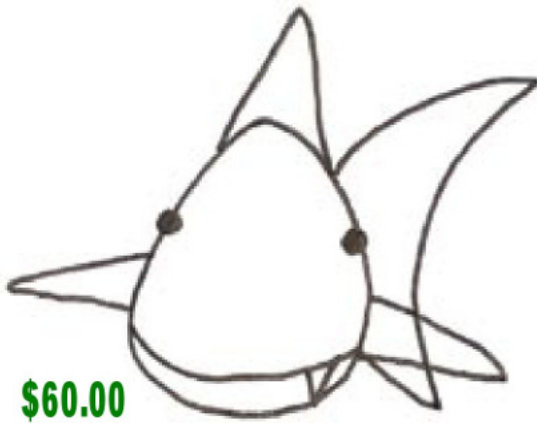

**\$60.00**

#461-2  
Sheldon Shark  
Approx. 21-3/4"H x 29-1/2"W  
Br. Stl or Natrl ONLY

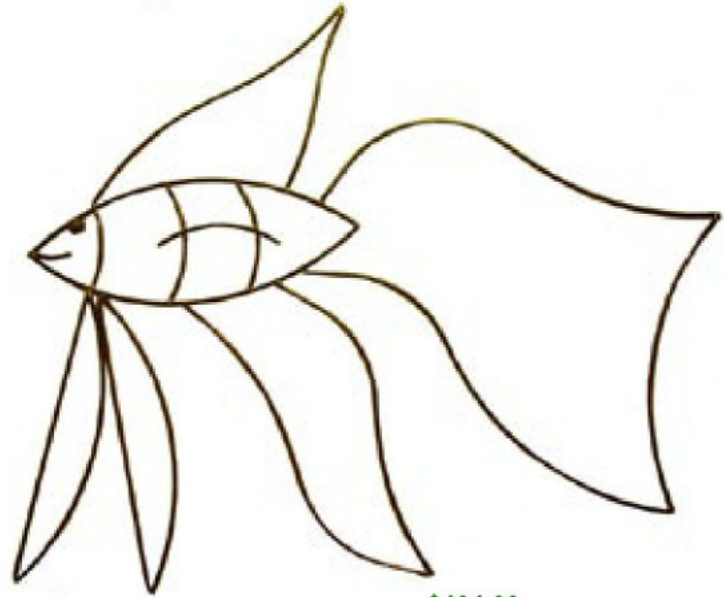

#461-3 **\$101.00**

Bob the Betta  
Approx. 30-3/4"H x 37"W  
Br. Stl or Natrl ONLY

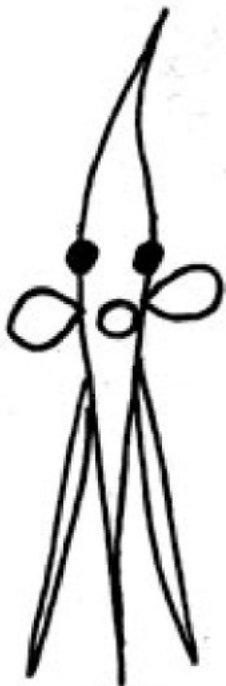

**\$68.00**

#461-5  
Amy Angelfish  
Approx. 36"H x 12"W  
Br. Stl or Natrl ONLY

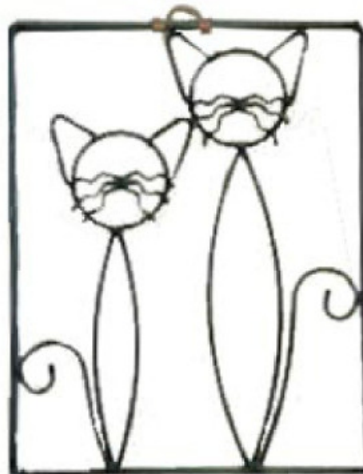

#445-6 **\$53.00**  
Together Cats  
Approx. 20"H x 15"W  
Br. Stl or Natrl ONLY

ALSO AVAILABLE

#446-6 **\$53.00**  
Together Dogs  
Approx. 20"H x 15"W  
Br. Stl or Natrl ONLY





**\$34.00**

#052-9  
Hanging Bird Bath Bowl Holder  
Approx. 16 - 18" H + 8-3/4" ring  
Black, Br.Stl or Natrl  
*Bowl supplied by Kathy, Thanks*



**\$29.00**

#539-5  
Branch Hanger  
Approx. 20"L  
Br.Stl or Natrl ONLY

**\$15.00**

#295-1

**\$14.50**

295-2



#295-1, #295-2  
Wreath Hangers  
/ Over the door Hooks  
approx. 14"L x 3"Dp  
Black, Br.Stl or Natrl  
*I use mine for draping my bath sheet*



**\$83.00**

#419  
Hose Holder  
Approx. 17"H x 21"W x 9"Dp  
Black, Br.Stl or Natrl



**\$58.00**

#031-3  
Gothic Scroll Garden Hook  
Approx. 84"H  
Breaks down for shipping.  
Black, Br.Stl or Natrl  
*This hook looks great empty in the garden over the winter!*



#035  
Mini Garden Hook  
Approx. 40" [+ foot] x 8"  
*Great ffor those small planters or a windchime!*  
Black, Br.Stl or Natrl

**\$21.00**



#067-629

#434  
Small Sign Post  
Approx/ 53"H x 24"W  
Black, Black, Br.Stl or Natrl  
*Great for the cottage, trailer or to really show off your house number!*

**\$77.00**





\$25.00



\$24.00



\$21.00



\$23.00

### The Swivel System

Choose a back for the wall and add one of the accessories to finish.

Eg. 067-625 = Lr. Dbl Spiral with Lr. Planter Ring



\$11.00



\$19.00



\$28.00



\$23.00



\$35.00





#078 **\$58.00**  
 Cabriole Tripod  
 Approx. 22"H x 12"Dm  
 Black, Br.Stl or Natrl  
*Excellent for planters, bowls, candleplatters or a small table top. My bowl.*



#074, Ball #075, Finial  
 2 Ring Plant Stands **\$93.00**  
 Approx. 58"H x 13"Sq.  
 Black, Br.Stl or Natrl  
*Designed to take 10" hanging pots when the hangers break. They Also make awesome obelisks!*



Funky Spiral Back Tripods  
 #079-1, Approx. **\$53.00**  
 #079-2 **\$59.00**  
 #079-3 **\$67.00**  
 #079-123, Set of 3 **\$154.00**  
 Black, Br.Stl or Natrl



#481-9 **\$58.00**  
 Tulip Planter  
 Approx. 20"H x 15"Dm + stakes  
 Br.Stl or Natrl  
 ONLY  
 For garden or pot



#095-1, Finials - #095-2, Flanged  
 Approx. 27-1/2"H x 13"Sq  
 + "X" at 18" x 7-3/4"Sq.  
 Black, Br.Stl or Natrl



#095-3 Ball Tops  
 Approx. 20"H x 13"Sq.  
 + "X" at 18" x 7-3/4"Sq.  
 Black, Br.Stl or Natrl



#359, Round Table Base  
 Approx. 26-1/2"H x 18"Dm [Ring]  
 Black, Br.Stl or Natrl



#359-1, 1/2 Round  
 Approx. 26-1/2"H x 18"W x 9"Dp  
 Black, Br.Stl or Natrl

*The above row of items can be used for many things - as table bases, plant stands, bird bath stands, fire pot stands, fire chimney holders. The list can keep going on!*



#056 **\$41.00**  
 Double Pot Stand  
 Approx. 16"H x 27"W x 11"Dp  
 Black, Br.Stl or Natrl  
*A great way to raise a rectangular planter box . Also looks good on a deep ledge.*



  
 Pot Scroll-Stakes  
 #055-1, Sm.  
 Approx. 18"H  
 #055-2, Md.  
 Approx. 30"H  
 #055-3, Lr.  
 Approx. 42"H  
 #055-123, Set of 3 **\$68.00**  
 Black, Br.Stl or Natrl  
*I'm using mine for bird houses!*





**\$261.00**

#0710-R  
Victorian Basket with Stand  
Basket as described under #071-R  
Stand approx. 30"H  
Black, Br.Stl or Natrl

#071-355  
Basket Stand ONLY **\$188.00**  
Approx. 30"H x 34"L x 13"Dp  
Black, Br.Stl or Natrl



#071-R  
Victorian Planter Window Box Available Up to 10' Wide  
OD/ Approx. 40-1/2"L x 9"H x 13"Dp **\$117.00**  
ID/ Approx. 34"L x 7-1/2"H x 9-1/4"Dp  
-X- Custom sizing Available  
Black, Br.Stl or Natrl

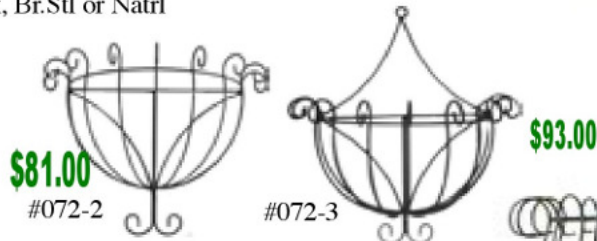

**\$81.00**

#072-2

**\$93.00**

#072-3

Small Wall Baskets  
#072-2 no raised back  
#072-3, raised back  
#072-1 No back, no bottom curls  
[not shown] **\$72.00**  
Approx basket size =  
OD/ 24"W x 18"H x 12.5"Dp  
ID/ 18"W x 10-1/4"H x 10"DP,  
narrowing to 5"Dp  
Note raised back = 8", Curls = 4"  
Black, Br.Stl or Natrl



#071-6  
Flower Planter Box **\$94.00**  
OD/ Approx. 35-1/2"L x 7-1/2"H x 10"Dp  
id/ Approx. 34-1/2"L x 6-1/2"H x 9"Dp  
Black, Br.Stl or Natural



**\$235.00**

#073-99  
Dlx. Basket & Stand  
Approx. 42"H x 30"Dm  
Black, Br.Stl or Natrl  
*I love this piece!*



**\$118.00**

#466-3  
Trellis Back Basket  
Approx.  
33-1/2"H x 20"W x 13"Dp  
Basket ID =  
7"H x 14"W x 9"Dp  
Black, Br. Stl or Natrl



**\$136.00**

#466-5  
Dlx. Wall Planter  
Approx.  
37"H x 27-1/2" x 12"Dp /  
basket = 6"H  
Black, BrStl or Natrl



**\$118.00**

#466-7  
Arch Top Wall Basket





**\$33.00**

#054-1  
2 ring Ivy Planter  
Approx 20"H x 10"W  
+ 2, 5-3/4"ID rings  
Black, Br.Stl or Natrl



**\$35.00**

#054-2  
2 ring Ivy Planter  
Approx 20"H x 10"W  
+ 2, 5-3/4"ID rings  
Black, Br.Stl or Natrl



**\$46.00**

#054-3  
Funky Heart Planter  
Approx. 24"H x 16"W  
Black, Br.Stl or Natrl



**\$46.00**

#054-4  
Daisy Saddle Planter  
Approx. 24"H x 10"W  
Black, Br.Stl or Natrl



**\$25.00**

#054-6  
Simple Scroll Pot  
Holder  
Approx. 16"H  
Black, Br. Stl or Natrl

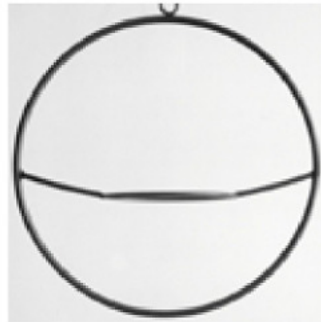

**\$46.00**

#070-1  
Lr. Circle Planter  
Approx. 22"Dm  
+ 9-3/4"ID ring  
Black, Br.Stl or Natrl



**\$41.00**

#070-2  
Tear Drop Planter  
Approx. 20"H  
+ 5-3/4"ID ring  
Black, Br.Stl or Natrl



**\$35.00**

#267  
Diagonal Planter  
Approx. 22"L + 4" coils  
Black, Br.Stl or Natrl  
*Look familiar?  
Its our 4 bottle wine rack!*



**\$58.00**

#451-2  
Daisy Bouquet Planter  
Approx. 24"H x 18W  
+ 5-3/4"ID ring  
Black, Br.Stl or Natrl



**\$154.00**

#465-2  
Wall Grille Planter  
Approx. 36"H x 24"W  
+ 2, 5-3/4ID rings  
Black, Br.Stl or Natrl

**ANGEL Planters**  
*See Page 47*





#444-9 **\$38.00**  
Goony Bird Planter Pal  
Approx. 24"H  
Black, Br.Stl or Natrl



#445-2 **\$58.00**  
Wall Cat Planter  
Approx. 28" x 21" W x  
7"Dp + 5-3/4"ID ring  
Br.Stl or Natrl



#446-2 **\$58.00**  
Wall Dog Planter  
Approx. 28" x 18" W x  
7"Dp + 5-3/4"ID ring  
Br.Stl or Natrl



#445-3 **\$52.00**  
Potting Cat  
Approx 28"H x 12"Dm  
+ 5-3/4"ID ring  
Br.Stl or Natrl



#446-3 **\$52.00**  
Potting Dog  
Approx 28"H x 12"Dm  
+ 5-3/4"ID ring  
Br.Stl or Natrl



#445-9 **\$58.00**  
Cat Planter Pal  
Approx. 22"H x 22"L  
+ 10-3/4"ID ring  
Br.Stl or Natrl



#446-9 **\$58.00**  
Dog Planter Pal  
Approx. 22"H x 22"L  
+ 10-3/4"ID ring  
Br.Stl or Natrl



#445-10 **\$35.00**  
Kitten Planter Pal  
Apprx. 15"H x 13"L  
+ 5-3/4"ring  
Br.Stl or Natrl



#446-10 **\$35.00**  
Puppy Planter Pal  
Apprx. 15"H x 13"L  
+ 5-3/4"ring  
Br.Stl or Natrl



#447-9 **\$58.00**  
Bunny Planter Pal  
Approx. 25"H + 9-3/4"ID ring  
Br.Stl or Natrl



#448-9 **\$58.00**  
Lr. Reindeer Planter  
Approx. 29"H + 9-3/4"ID ring



#448-10 **\$35.00**  
Sm. Reindeer Planter  
Approx. 15"H + 5-3/4"ID ring  
Br.Stl or Natrl

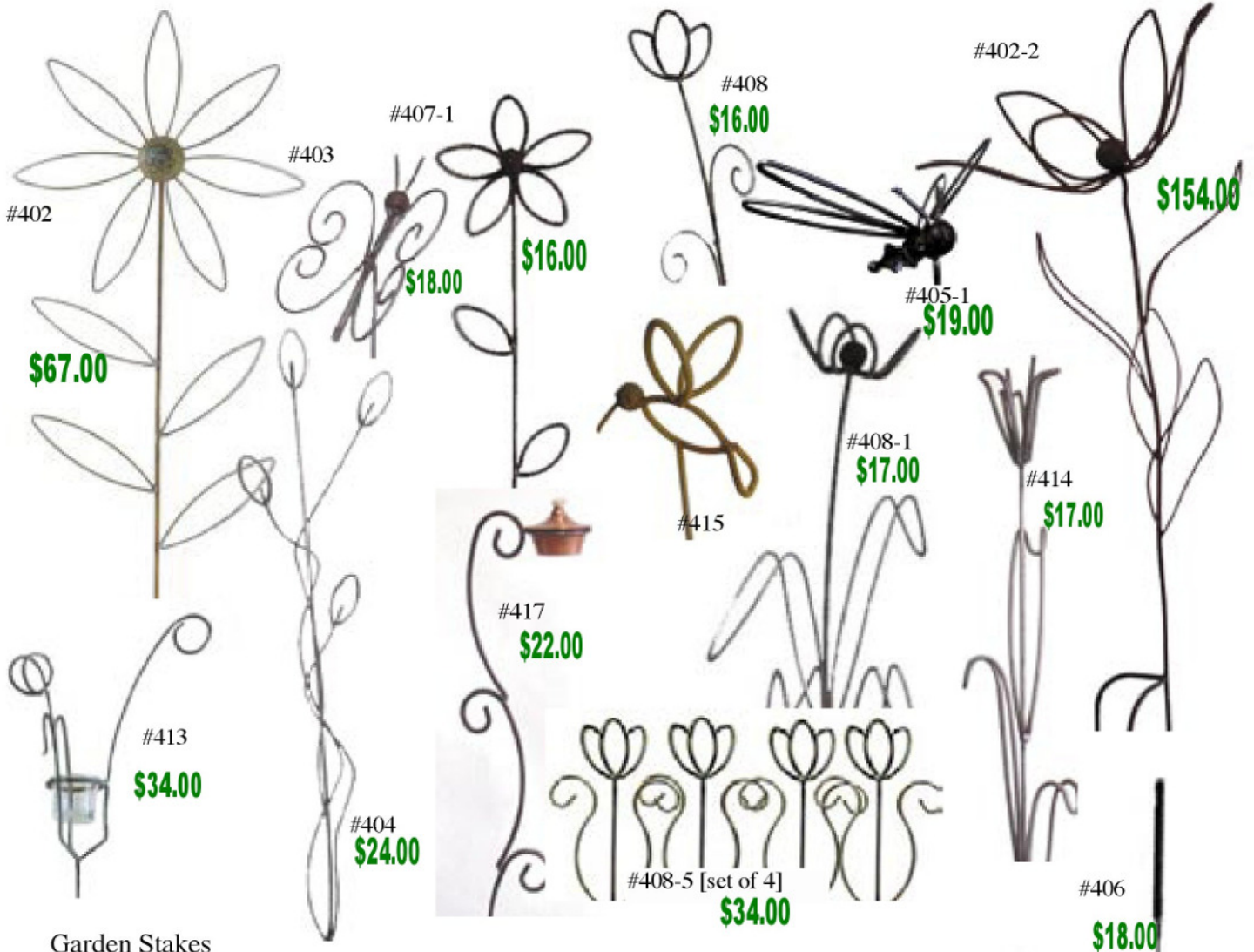

Garden Stakes

Available in Natural ONLY and with 40" stakes... Unless otherwise listed below.



- #402..... Giant Daisy Stake, Approx. 74"H x 28"W
- #402-2..... Large Open Flower, Approx. 65"H x 30"
- #403..... Butterfly
- #404..... Garden Vine
- #405-1..... Dragonfly
- #406..... Bullrush
- #407-1..... 5-Point Daisy
- #408..... Closed Tulip
- #408-1..... Open Tulip [or Poppy]
- #408-5..... Mini Tulip, set of 4. Approx.17"H/each
- #413..... Votive Swirl Stake with Votive, #413 -1....Votive Swirl - NO glass
- #414..... Calla Lil...
- #415..... Humming Bird
- #417..... Scroll Stem Votive Stake - comes empty

*Decorate a planter or a fill a spot in your garden. Our garden stakes are guarenteed to rust!*

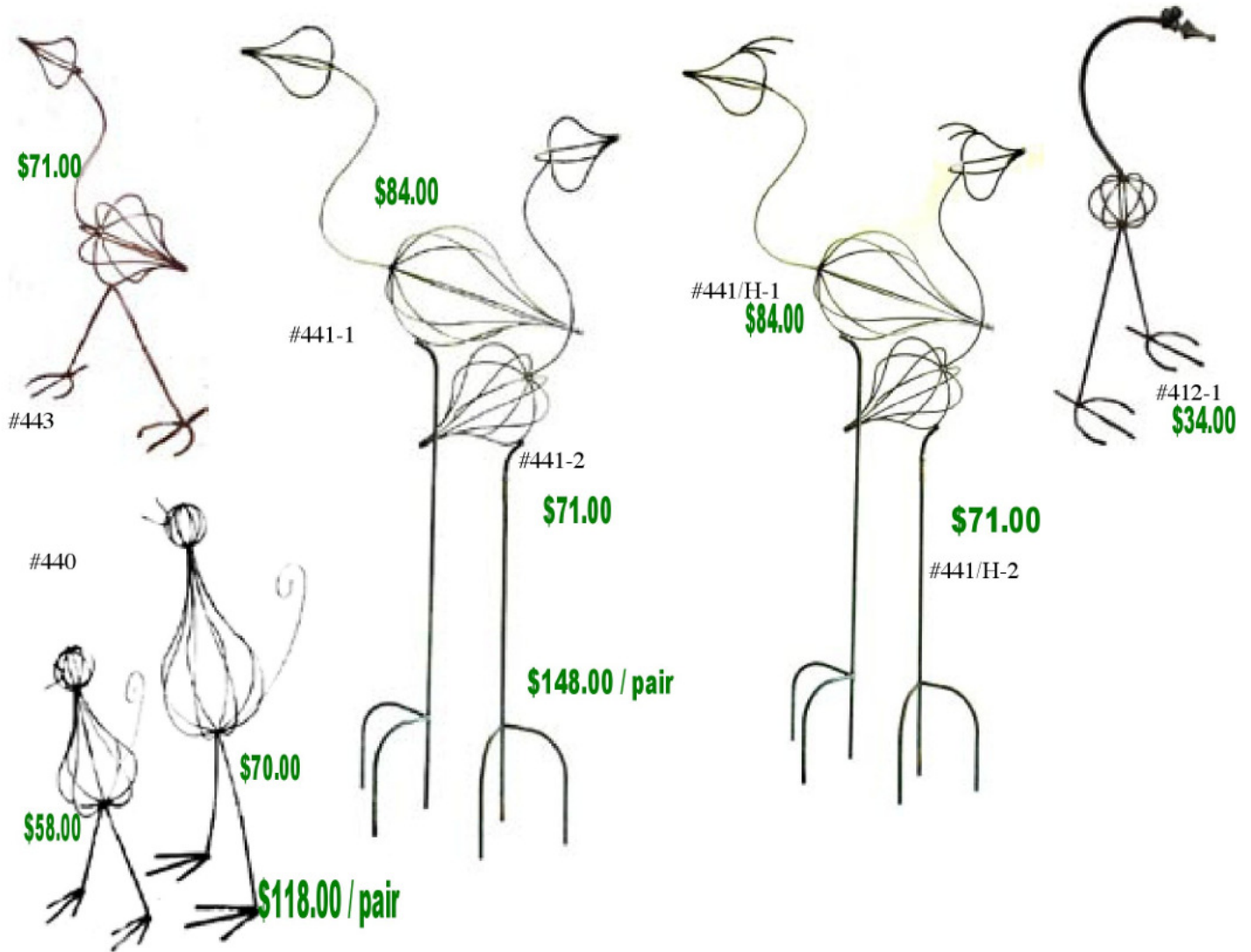

#440, Garden Sparrows, PAIR  
 #440-1, LR. Sparrow, Approx. 47”H x 24”  
 #440-2, SM. Sparrow, Approx. 37”H x 22”



#441, Garden Cranes, PAIR  
 #441-1, LR. Crane, Approx. 80”H x 24”  
 #441-2, SM. Crane, Approx. 72”H x 18”

#441/H, Garden Herons, PAIR  
 #441/H-1, LR. Heron, Approx. 83”H x 24”  
 #441/H-2, SM. Heron, Approx. 75”H x 18”

#443, Canada Goose, Approx. 48”H x 24”

#412-1, Junior the Garden Bird, Approx. 48”H

*Just plant any of these birds somewhere in your garden, in plain site or peeking out from among ferns, plant with climbing vine or just enjoy the frame work.*



#441/H-1



#411  
Funky Bug  
Approx.  
11"H X 16"W X 12"Dp  
Natural ONLY  
Hang it on a wall or ceiling  
by a foot, from a hook by a  
wing or just leave it on a  
table. *Charity's 1st design!*

**\$29.00**



#445  
Garden Cat  
Approx. 28"H x 20"Dm  
Br.Stl or Natrl ONLY

**\$70.00**



#446  
Garden Dog  
Approx. 28"H x 20"Dm  
Br.Stl or Natrl ONLY

**\$70.00**

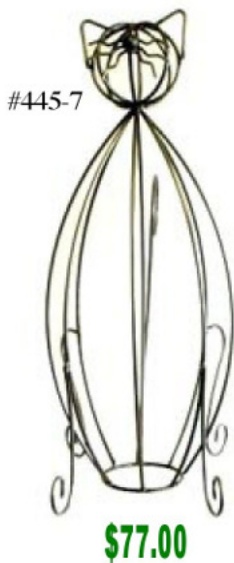

#445-7

#445-7  
Garden Cat Cage  
#446-7  
Garden Dog Cage  
Approx. 26"H x 20"Dm  
Br.Stl or Natrl ONLY  
*Plant inside the opening and enjoy!*

**\$77.00**



#446-7

**\$77.00**



**\$117.00**

#438  
Tree Trellis  
Approx. 48"H [+ legs] x 15"Dm  
Natural ONLY  
*You should see mine in bloom with  
climatis! [www.wroughtiron.on.ca](http://www.wroughtiron.on.ca)*



**\$92.00**

#438-1  
Shrub Trellis  
Approx. 24"H [+ legs] x 15"Dm  
Natural ONLY  
*I can't wait to plant this in a big  
pot on our patio with a container  
climatis!*



**\$35.00**

#481-1  
Tulip Topiary  
Approx. 36"H x 16"Dm  
[+ legs]  
ALSO available  
#481-2  
Approx. 60"H x 24"W "  
Natural ONLY **\$84.00**

Oblong Tiered Topiary  
 #430-1, Approx. 15"H  
 #430-2, Approx. 30"H  
 #430-3, Approx. 55"H  
 #430-4, Approx. 60"H  
 #430-5, Approx. 70"H  
 Natural ONLY

Measurement does not include legs,  
 4th + 5th tiers are approx. 10"H  
*Slender and elegant these topiary  
 frames will make an elegant image  
 with ivy or a container  
 climatis planted in a pot  
 on the patio or deck or  
 along a walkway garden.*



\$29.00

#430-1

\$35.00  
 #430-2

\$37.00  
 #430-3

\$39.00  
 #430-4

\$41.00  
 #430-5



\$39.00

#431-1  
 3 Tier Tear Drop Topiary  
*Rick calls this the onion tower!*  
 Approx. 60"H x 16"Dm  
 Natural ONLY



\$39.00

431-2  
 Finial Center Topiary Ap-  
 prox. 31"H x 12"Dm  
 Natural ONLY



\$37.00

#431-3  
 Tri-Scroll Topiary  
 Approx. 36" H x 14"W [+  
 legs]  
 Natural ONLY



\$37.00

#431-4  
 Scroll Spade Topiary  
 Approx. 36"H x 14"W  
 [+ legs]  
 Natural ONLY

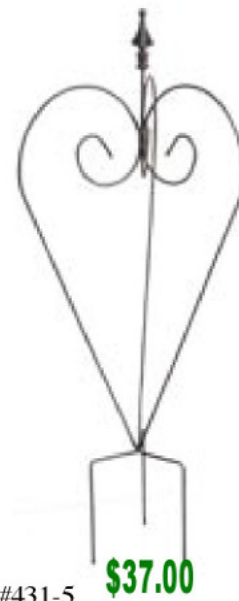

\$37.00

#431-5  
 Scroll Heart Topiary  
 Approx. 46"H x 14"W [+  
 legs]  
 Natural ONLY



\$154.00

#428-1  
SM. Open Center Flower  
Obelisk  
Approx. 63"H x 18"Base  
- 4 sides  
Natural ONLY



\$165.00

#428-2  
LR. Open Center Flower Obelisk  
Approx. 75"H x 20"Base - 4 sides  
Natural ONLY

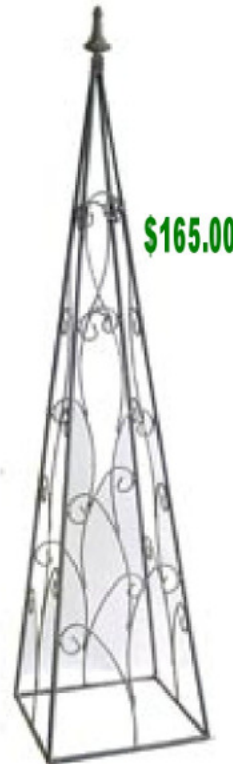

\$165.00

#429  
Open Center Split-Scroll  
Obelisk  
Approx. 65"H x 18"Base  
Natural ONLY



\$106.00

#428-9  
A-Frame Folding Flower  
Trellis  
Approx. 65"H  
*Hang a plant from the hook!*



#428-9



\$24.00

\$22.00

\$19.00



\$59.00

#426-6, Set of 3  
Copper Top Open Obelisks  
#424-6, SM. Approx. 30"H  
#425-6, MD. Approx. 40"H  
#425-6, LR. Approx. 53"H  
Natural ONLY, *Guaranteed to rust*  
*Great for container gardening.*





#426, Spiral Obelisks, Set of 3  
 - Finial Top  
 #423, SM. Approx. 33"H  
 #424, MD. Approx. 43"H  
 #425, LR. Approx. 55"H  
 Natural ONLY



Great Container Obelisks!  
 #426-1, Spiral Obelisks, Set of 3  
 - Tear Drop Top  
 #423-1, SM. Approx. 36"H  
 #424-1, MD. Approx. 48"H  
 #425-1, LR. Approx. 60"H  
 Natural ONLY  
*You asked for them back... so here they are!*



#433  
 Simple Spear Top Triad Obelisk  
 Approx. 60"H x 10"Dm  
 Natural ONLY

Folds up for shipping



#021-1 Mini Hoop Top Obelisk  
 Approx. 48"H x 8"Sq.  
 Natural ONLY



#028-1 \$46.00  
 Mini-Open Center Obelisk  
 Approx. 48"H x 12"Dm [ring]  
 Natural ONLY



#028-3 \$34.00  
 Mini-Open 1/2 Obelisk  
 Approx. 48"H x 12"W x 6"Dp  
 Natural ONLY

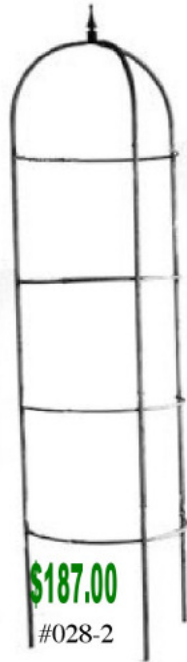

Open Center Obelisks - the Big Ones - Also called Rose Cages  
 #028, Full Round, Approx. 72"H x 15"Dm  
 #028-2, 1/2 Round, Approx. 72"H x 15"W x 7.5"Dp  
 #028-4, Full Round, Column/ NO Top, Approx. 65"H x 15"Dm  
 Black, Br.Stl or Natural

#022-1  
 Cage Teuteur  
 Approx. 72"H x 15" SQ-base  
 Black, Br.Stl or Natrl



#023  
 Spear Obelisk  
 Approx. 76"H x 15"Sq.Base  
 Black, Br.Stl or Natrl  
**\$199.00**



#023-1  
 Flat Back Spear Obelisk  
 Approx. 76"H x 15"W x  
 10.75"Dp  
 Black, Br.Stl or Natrl  
**\$163.00**





#020 **\$176.00**  
 Ball Top Obelisk  
 Approx. 72"H x 13"OD Sq.  
 Black, Br.Stl or Natrl



#020-1 **\$176.00**  
 Finial Top Obelisk  
 Approx. 72"H x  
 13"OD Sq.  
 Black, Br.Stl or Natrl

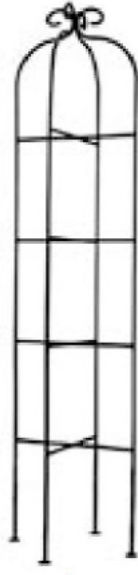

020-4 **\$187.00**  
 Scroll Top Obelisk  
 Approx. 72"H x 13"OD Sq.  
 Black, Br.Stl or Natrl

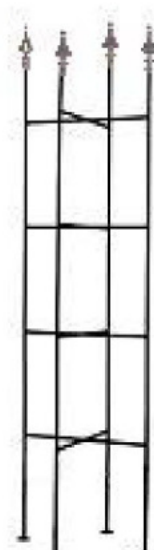

#020-5 **\$167.00**  
 Simple Column Obelisk  
 Approx. 72"H x 13"OD Sq.  
 Black, Br.Stl or Natrl



Note:  
 This type of obelisk  
 make excellent shelving stands!

ID on all is 12" x 12" for 12" shelving or  
 12"SQ tiles, etc.

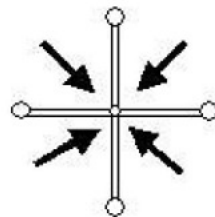

Configuration is an a  
 Plant climbers and allow to  
 intermingle



As a change from wood, take a step back in time to a wrought iron arbour. Our arbours come in a many designs from simple to decorative, from elegant nostalgia to fun and funky. We have 4 basic styles and a variety of decorative side designs to make your arbour unique.



#001  
Simple Hoop Top  
Approx. 7'H x 4'W x 2'Dp



#002  
Simple Scroll Top  
Approx. 7'5\"H x 4'W x 2'Dp



#006  
Simple Gothic Top  
Approx. 7'5\"H x 4'W x 2'Dp



#002-03

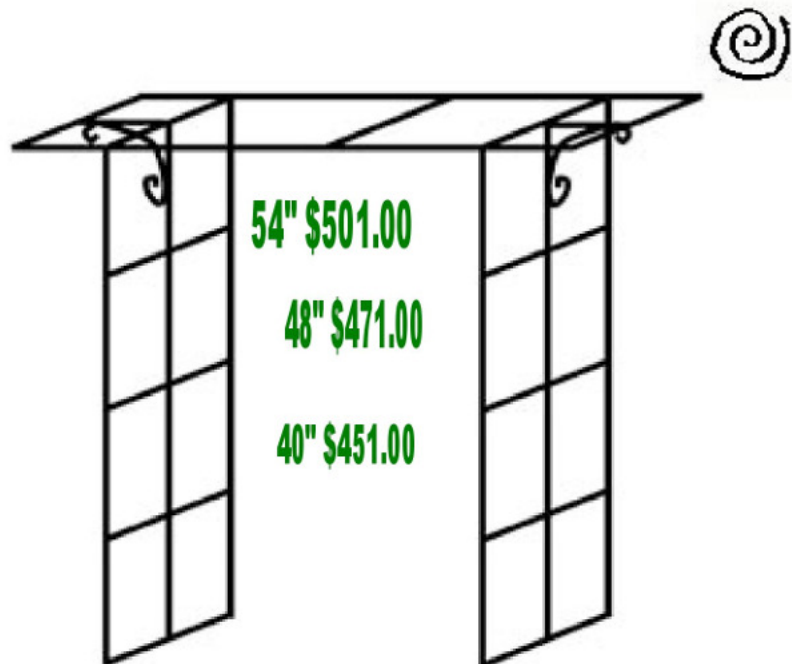

#009  
Simple Flat Top  
Approx. 7'H x 2'Dp x 4'ID-W/ 6'OD-W

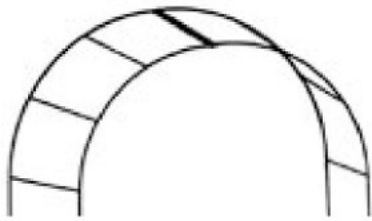

Choose between RUNG Top  
or [OT] OPEN Top



HOW TO ORDER ARBOURS:

You're probably thinking this is going to be complicated... not so.

Simply choose the style you want - hoop, scroll or gothic.. choose open or closed in top.. and if you wish to choose a different inset, do so.

EG.

A Scroll Top, Rung Top with a Victorian Trellis Inset.. order #002-A-03!

A Split Ladder Simple Hoop Top [and you want the bar to go all the way around]... #001-05 You don't even have to put in the [A], we'll go by the info you give us related to the pictures you see.

How about #009-062... You want a Simple Flat Top Arbour with an English Trellis Inset.

Any questions? Call us. 1-800-461-6758!

*Please note these tops are not available for Arbour #009*



#01 = English Trellis #02 = Funky Double Spiral #03 = Victorian Trellis  
 #04 = Scroll Trellis #05 = Split Ladder, which continues around chosen Arbour.  
 #06 = Finial Post #061 = Simple Post #08 = Tulip Trellis



#011  
Gothic Bower  
Approx. 7'6"H x 48"W x 24"Dp  
Holds Large Simple Trellis  
unless otherwise requested

Customizing available

As with our standard arbours, you may choose the pattern of your choice to the sides and even to the trellising if you wish.

It works like this:  
#011-A-042-042  
Gothic Bower - Rung top - Scroll Trellis Sides  
- Scroll Trellis Back

*NOTE:*  
Joining Trellis *SHOWN* is customized  
to 4" centers



About Accessories:  
Everything from Hooks, to Planter Rings, to Baskets

- #610-1, 5-3/4" Ring [6" pot] **\$13.00**
- #615-1, 9-3/4" Ring [10" pot] **\$15.00**
- #620-1, 8" Hook **\$14.00**
- #620-1, 10" Scroll Hook - *Shown* **\$15.00**
- #625-1, 14" Hook - *Shown* **\$15.00**
- #640-1, Round Basket with extension arm [600-1] **\$44.00**



Back by popular demmand... the Arbour Bonnet!  
Designed to fit over 36" openings for gates, mounting on the 3-1/2" square posts.  
Don't worry - we custom size them for wider openings!



STARTER SIZE:  
Approx 38-1/2"W x 18"H x 20"Dp  
*to center on posts which have a 36" opening*

#010-06  
Gothic Arbour Bonnet  
**\$176.00**

#010-01  
Hoop Top Arbour Bonnet

**\$165.00**

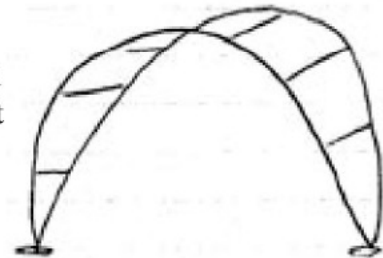

Arbour Bars for Gate Tops

Sometimes a simpler straddler is wanted for over a gate when the posts are much taller than the gate. These are our solution.

ALL are designed to fit over posts 38-1/2"ID/W, arches are approx. 18"H



#012-1  
Arch Top Scroll Bar

**\$116.00**



#012-2  
Open Scroll Bar

**\$92.00**



#012-3  
Enclosed Split Scroll Bar

**\$139.00**



#010-06

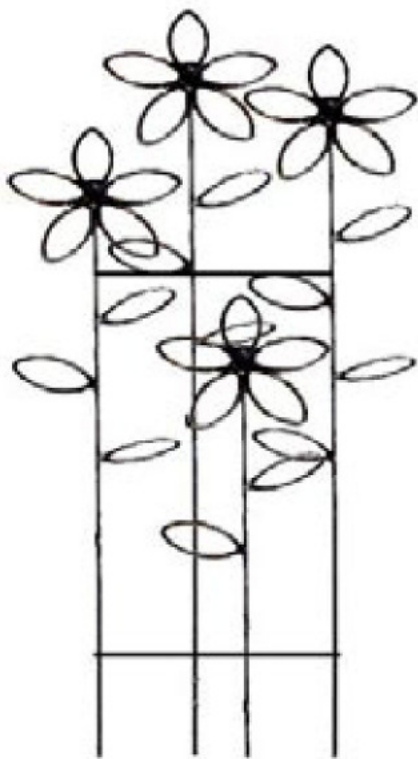

**\$113.00**

#407040  
Daisy Trellis  
Approx. 65"H [+ legs] x 30"W  
Natural ONLY

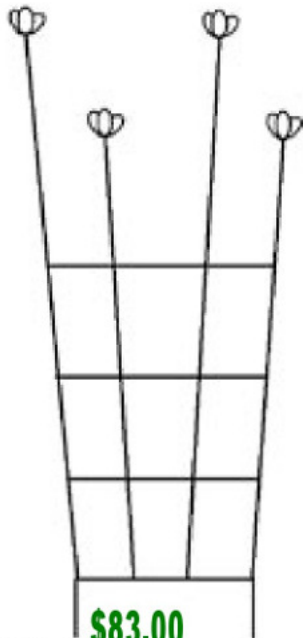

**\$83.00**

#040-61  
SM. Tulip Trellis [4 Stem]  
Approx. 60"H x 12"base - 20"W/top  
Natural ONLY

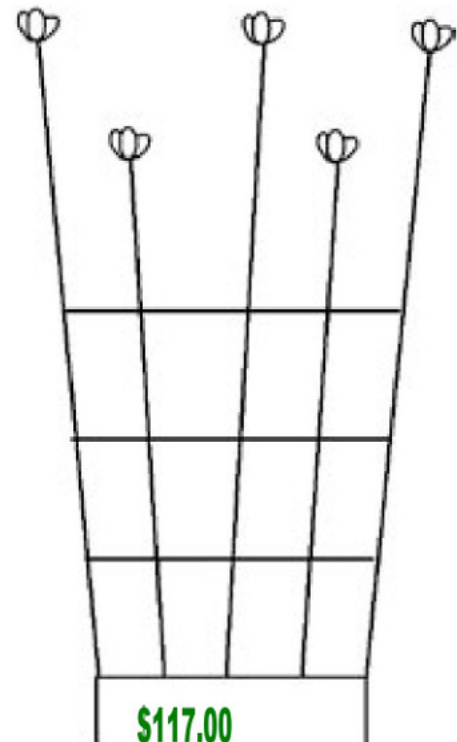

**\$117.00**

#040-62  
LR. Tulip Trellis [5 Stem]  
Approx. 65"H x 20"base - 26"W/top  
Natural ONLY

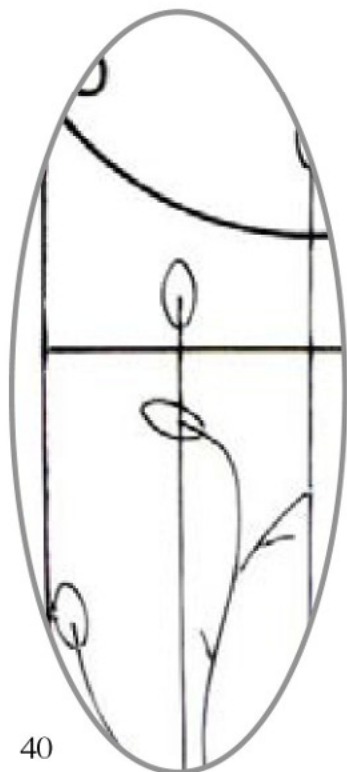

40



**\$29.00**

#410  
Mini Vine Trellis  
Approx. 48"H [+ legs] x 12"W  
Natural ONLY  
*Yep, its our garden stake #404, bigger with horseshoe legs and they're a big seller - I've got one too!*

**\$52.00**

#482-1  
SM. Flower Trellis  
Approx. 36"H [+ legs] x 16"W  
#482-2 **SHOWN**  
LR. Flower Trellis  
Approx. 65"H [+ legs] x 24"W  
Natural ONLY

**\$106.00**

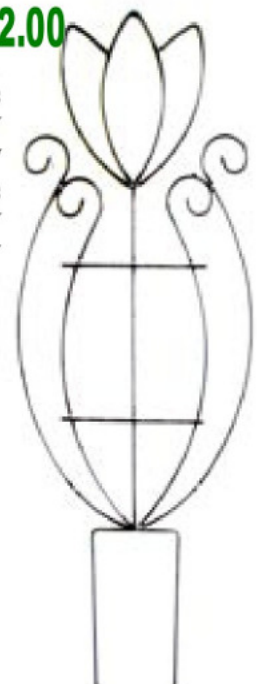





**\$139.00**

#041-1  
Scroll & Ball Trellis  
Approx. 65"H [+ legs] x 26"W  
Natural ONLY



**\$171.00**

#041-2  
Scroll & Ivy Trellis  
Approx. 65"H [+ legs] x 26"W  
Natural ONLY



**\$201.00**

#041-7  
Magnolia Curve Trellis  
Approx.  
65"H x 26"W x 4-6"Dp  
Black, Br.Stl or Natrl



**\$59.00**

#049-5  
SM. Multi-Scroll  
Trellis/ Stake  
Approx.  
40"H [+ legs] x 12"W  
Black, Br.Stl or Natrl



**\$106.00**

#045  
Victorian Spade Trellis  
Approx. 65"H [+ legs] x 24"W  
Black, Br.Stl or Natrl

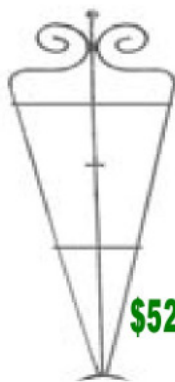

**\$52.00**

#045-36  
Mini Victorian Spade Trellis  
Approx.  
36"H [+ legs] x 12"W  
Black, Br.Stl or Natrl



**\$106.00**

#045-2  
Victorian Spade Trellis/ Multi- Scroll  
Approx. 65"H [+ legs] x 24"W  
Black, Br.Stl or Natrl



**\$47.00**

#045-5  
SM. Oval & Scroll Trellis  
Approx. 30"H [+legs] x 16"W



**\$81.00**

#045-6  
LR. Oval & Scroll Trellis  
Approx. 65"H [+ legs] x 24"W  
Black, Br.Stl or Natrl



Small Wall Trellises

- #042-1, Hanging, Approx. 78”L x 22”W
  - #042-2, Simple Scroll, Approx. 72”H x 22”W
  - #042-3, Multi Scroll, Approx. 72”H x 22”W
  - #042-4, Mini, Approx. 36”H x 14”W
- Black, Br.Stl or Natural

Small Wall Trellises

- #042-5, Simple Finial Top, Approx. 65”H x 24”W
  - #042-6, SM. Fan, Approx. 72”H [+ ] x 24”W
  - #042-61, Mini Fan, Approx. 42”H x 12”W
- Black, Br.Stl or Natrl



Corner Trellises

- #047, LR. Scroll, Approx. 78”H x 20”x22”
  - #047-3, SM. Scroll, Approx. 65”H x 12”x12”
  - #047-5, LR. Simple, Approx. 65”H x 24”x24”
- Black, Br.Stl or Natrl

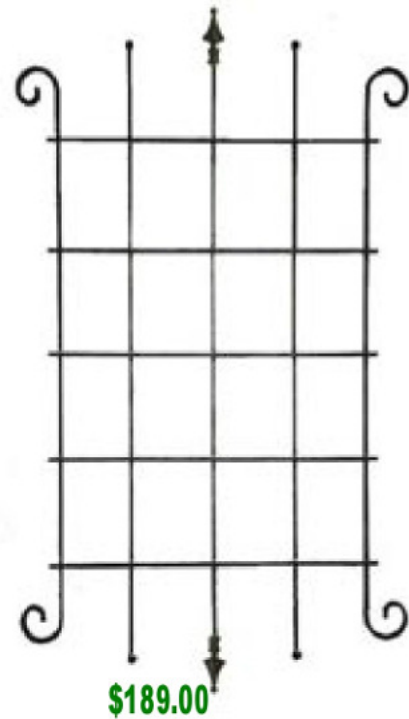

#046-1

- LR. Hanging Wall Trellis
- Approx. 78”H x 42”W
- 3 wall anchors included.
- Black, Br.Stl or Natrl



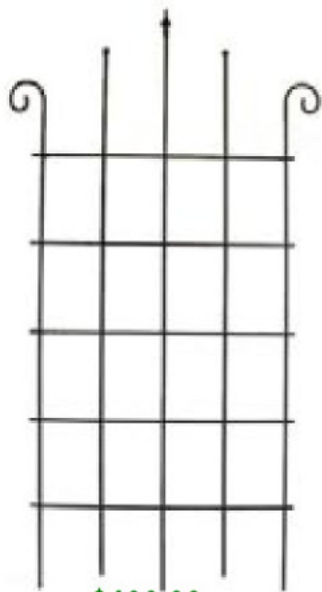

**\$166.00**

#046-2  
Lr. Wall Trellis  
Approx. 78"H x 42"W  
Black, Br.Stl or Natrl



**\$189.00**

#046-3  
Lr. Multi-Scroll Trellis  
Approx. 78"H x 42"W  
Black, Br.Stl or Natrl

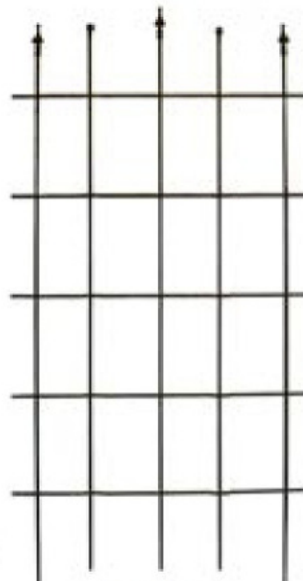

**\$143.00**

#046-5  
Lr. Simple Wall Trellis  
Approx. 65"H x 48"W  
Black, Br.Stl or Natrl



**\$154.00**

#046-6  
Lr. Fan Trellis  
Approx. 72"H x 36"W  
Black, Br.Stl or Natrl

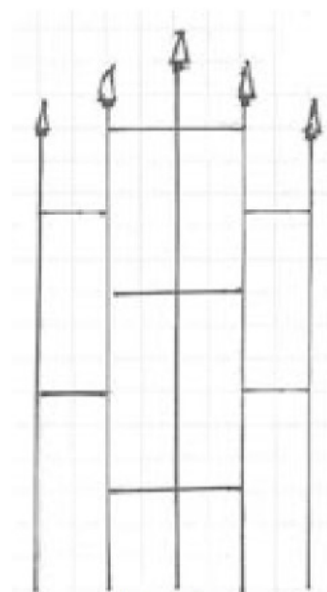

**\$154.00**

#046-7  
Staggered Top Trellis  
Approx. 78"H x 42"W  
Black, Br.Stl or Natrl

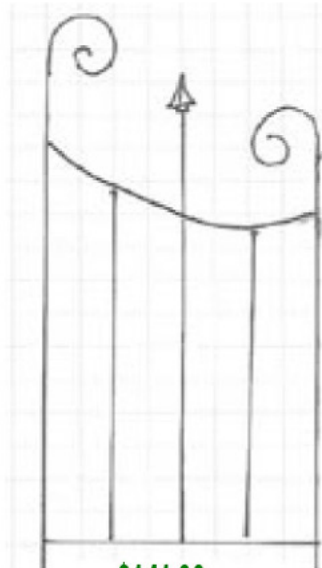

**\$141.00**

#040-5  
Funky Scroll Trellis  
Approx. 63"H x 36"W  
Black, Br.Stl or Natrl

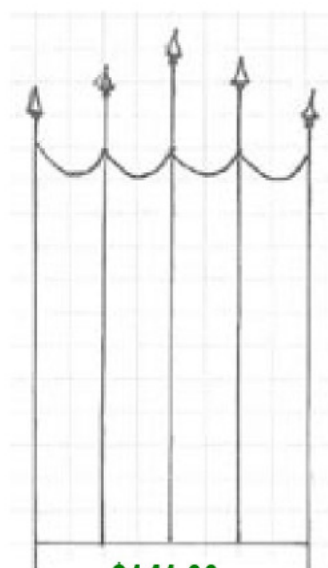

**\$141.00**

#046-9  
Gothic Spear Trellis  
Approx. 63"H x 36"W  
Black, Br.Stl or Natrl

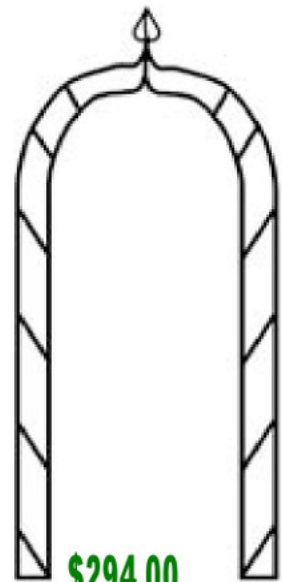

**\$294.00**

#048-006  
Gothic Arbour Trellis  
Approx. 72"H x 40"W  
[36"ID]  
Black, Br.Stl or Natrl





#470 **\$480.00**  
 Custom Finial Top Gate  
 Shown, Approx. 65"H x 40"W  
 Black, Br.Stl or Natural  
 -X- Custom Resizing [etc] Available



#471 **\$940.00**  
 Custom Arch Top Gate  
 Shown, Approx. 69"H x 44"W  
 Black, Br.Stl or Natrl  
 -X- Custom Resizing [etc] Available

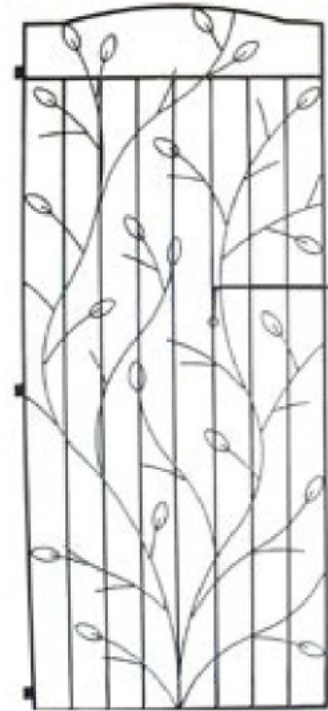

#473-1 **\$890.00**  
 Custom Open Ivy Gate  
 Shown, Approx. 72"H x 42"W  
 Black, Br.Stl or Natrl  
 -X- Custom Resizing [etc] Available



#479-1  
 Split Scroll Gate Insert  
 Approx. 18"H x 10"W  
 Black, Br.Stl or Natrl  
 -X- Custom Sizing Available

**\$84.00**

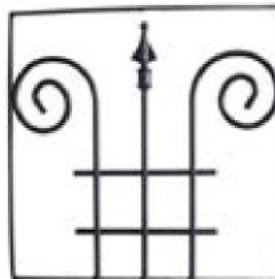

#479-4 **\$77.00**  
 Scroll Trellis Gate Insert  
 Approx. 18"Sq.  
 Black, Br.Stl or Natrl

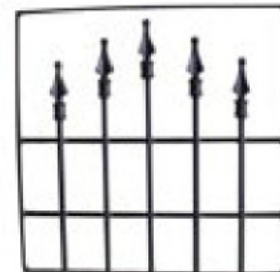

#479-5 **\$83.00**  
 Finial Trellis Gate Insert  
 Approx. 18"Sq.  
 Black, Br.Stl or Natrl

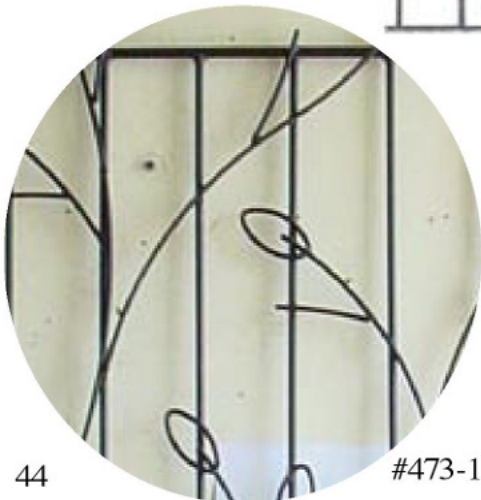

#479-3  
 Magnolia Branch Gate Insert  
 Approx. 20"H x 16"W  
 Black, Br.Stl or Natrl  
 -X- Custom sizing available

**\$83.00**





**\$470.00**  
 #326  
 Arch Back Bench with Asterisk Motif  
 Approx. 48”L x 31”H x 20”Dp  
 Seat = 42”L x 15-3/4”Dp  
 Black, Br. Stl, Antq.Stl or Natrl  
 Custom Resizing [etc] available



**\$413.00**  
 #326-1  
 Arch Back Bench with Butterflies  
 Approx. 30”L x 31”H x 20”Dp  
 Seat = 24”W x 15-3/7”Dp  
 Black, Br. Stl, Antq.Stl or Natrl  
 Custom resizing [etc] available



**\$433.00**  
 #327  
 Curved Arm Bench with Asterisk Motif  
 Approx. 48”L x 24”H x 20”Dp  
 Seat = 42”L x 15-3/4”Dp  
 Black, Br. Stl, Antq.Stl or Natrl  
 Custom resizing [etc] available



**\$413.00**  
 #327-1  
 Scroll Arm Bench with Scroll Motif  
 Approx. 40”L x 24”H x 20”Dp  
 Seat = 34”W x 15-3/4”Dp  
 Black, Br. Stl, Antq.Stl or Natrl  
 Custom resizing [etc] available



**\$410.00**  
 #328  
 Bench with Asterisk Motif  
 Approx. 48”L x 16-1/2”H x 20”Dp  
 Seat = 42”L x 15-3/4”Dp  
 Black, Br. Stl, Antq.Stl or Natrl  
 Custom resizing [etc] available





#295  
Door Hook/ Wreath  
Hanger  
Approx. 14"L x 3"Dp [Id  
for wreath]  
How about using one to  
hang a towel or robe?  
Black, Br.Stl or Natrl



#291  
Angel Pillar Holder  
13-1/2"H x 7"Dp  
Hang or stand - it does  
both!  
P / P2  
Br.Stl or Natrl

P = Pillar, P2 = Pillar with peg  
T = Taper, V = Votive



#292  
Angel Candelabra  
Approx. 36"H x 12"Dm  
Order H = Praying Hands or  
P / P2 / T / V  
Br.Stl or Natrl

*NOTE: the Lady has new wings,  
see #449-5*

**\$46.00**



#448-9  
**\$58.00**



#1490  
SM Christmas Tree  
Approx. 30"H x 24"Dm

**\$88.00**

A great way to display those  
favourite ornaments without losig  
them in amongst the rest

Stars NOT available

ALSO  
#1490-6  
our 6' Version  
Approx. 72"H x 26"Dm

**\$201.00**



**\$35.00**

#448-10

#448-9  
Lr. Reindeer Planter  
Approx. 29"H + 9-3/4"ID ring  
#448-10  
Sm. Reindeer Planter  
Approx. 15"H + 5-3/4"ID ring  
Br.Stl or Natrl



#449  
our original Garden Angel  
Approx. 51”H x 20”W x 12”Dp  
Natural ONLY



Simple Garden Angels  
#449-1, Sm, Approx. 35”H  
#449-2, Md. Approx. 44”H  
#449-3, Lr. Approx. 50”H  
#449-123, Set of 3  
Natural ONLY  
**\$159.00**



Potting Angels [5-3/4”ID ring]  
#449-5, Sm. Approx. 35”H **\$52.00**  
#449-6, Md. Approx. 44”H **\$63.00**  
#449-7, Lr. Approx. 50”H **\$74.00**  
#449-567 Set of 3 **\$181.00**  
#449-10 Table Potting Angel, Approx. 20”H



#4490  
Garden Fairy  
Approx. 34”H x 14”Dm  
P / P2 / V or F for a flower  
Br.Stl or Natrl  
**\$49.00**



#447 **\$57.00**  
Garden Bunny  
Approx. 35”H x 20”Dm  
Natural ONLY



#447-9 **\$58.00**  
Bunny Planter Pal  
Approx. 25”H + 9-3/4”ID ring  
Br.Stl or Natrl



YES, we do custom work!

We can customize one of our own products for you or we can custom produce for you an idea you have... perhaps we could make a version of something you can no longer find.

We'll give you an estimate of the cost and see what we can do for you!

PRODUCTS we customize regularly are;

Arbours, obelisks, trellises, gates, planter boxes, candelabra, wine racks, pot racks, CD and DVD racks... WELL, just about anything in our catalogue can be

customized... we'll let you know if it can't be done. For more ideas on what we can offer, check out our website at [www.hallmanironworks.on.ca](http://www.hallmanironworks.on.ca). Email us at [hallman@wroughtiron.on.ca](mailto:hallman@wroughtiron.on.ca)

We can work from a doodle, a picture or clipping... we've even worked off a television commercial!

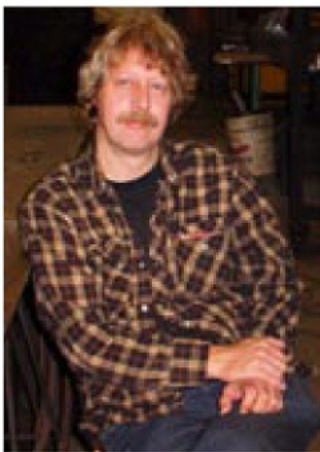

Hi! I am Rick Hallman. I am the owner and operator of Hallman Ironworks. Charity, the oldest of my two adult children, works with me. I am so proud of her. When I started this business back in 1991 I had no idea it would become a family business.

I am lead welder in our shop and produce the wrought iron in this catalogue and a lot more you may never see. To date our product line has gone well over 1,000 pieces, and we are producing the largest line of wrought iron in Canada!

I have the last word here at work and I guarantee to give you a product that is both attractive, sturdy and that will last for generations to come. You have my word on it.



Hi! I am Charity Warner. I am usually the voice you will hear when you call. I am also my Dad's right hand. This is good considering he is left handed.

I do everything from design, welding, finishing the products, quality control and shipping the finished products out. I do a lot of the computer work too, which includes the book keeping. I love learning new things. I hope to learn web design as well so I can help with more. So, as you can see, I have a lot of hats to juggle!

I look forward to hearing from you, and I would love to hear what you think of our product line and any ideas you may have for those you can't find anywhere. We love a challenge!

Call, email or fax I will get right back to you!



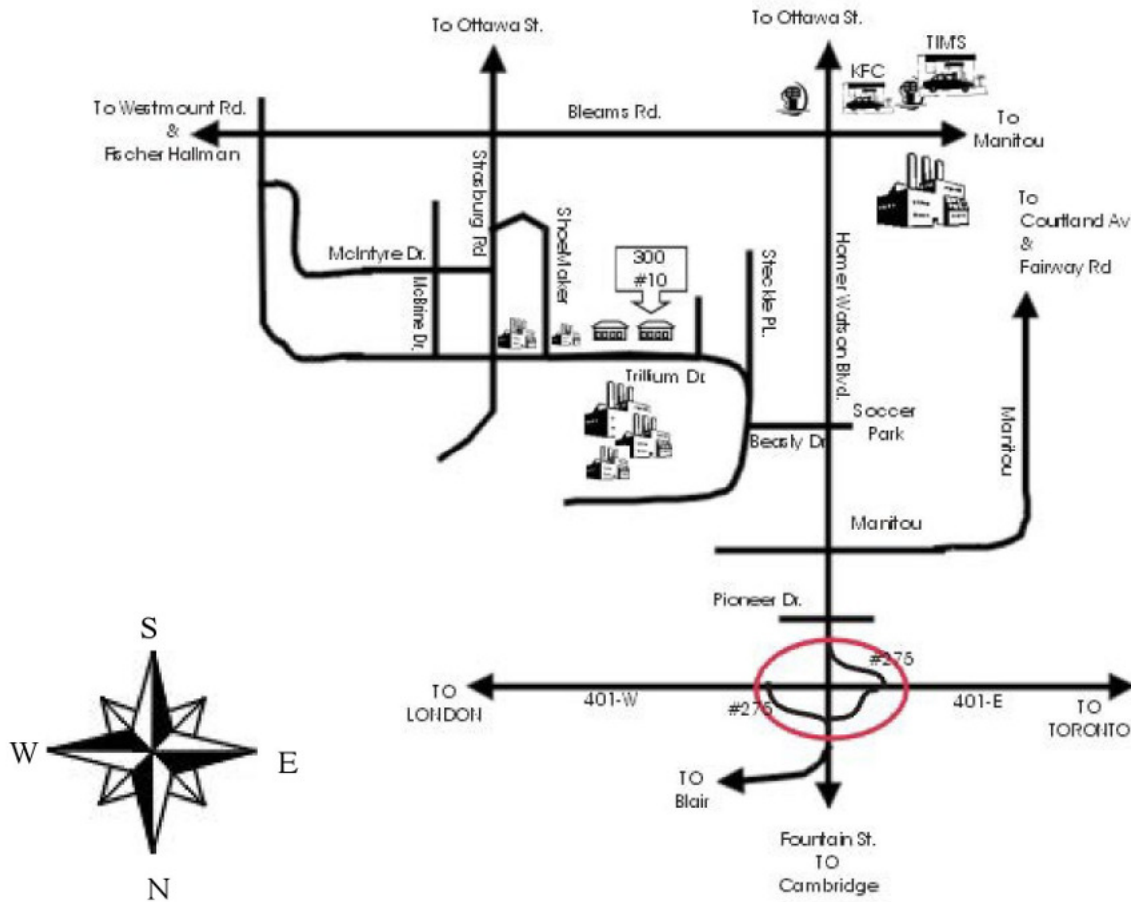

Please follow these directions... You are at the bottom of the map.

Take the 401 cut off to Kitchener/ Cambridge #275 - Homer Watson/ Fountain St.

Turn onto Homer Watson... Into Kitchener, not Cambridge!

Follow Homer Watson... Cross over Manitou and turn left at the next intersection [light] which is Beasley Dr.

Go to the STOP sign and turn right onto Trillium Drive - follow around the bend... we are on the right, in a small, grey brick industrial strip mall. Watch for our sign over our windows!

**Beds**  
**Barstools**  
**Arbours**  
**Trellises**  
**& more**

Wrought Iron Accents for the Home & Garden + Custom Work

# HALLMAN IRONworks

[www.wroughtiron.on.ca](http://www.wroughtiron.on.ca)
**519-894-6356**

# HALLMAN IRONworks

300 Trillium Drive, Unit 10  
Kitchener, Ontario  
N2E 2K6

Telephone:  
519-894-6356

Fax:  
519-894-1161

email:  
[hallman@wroughtiron.on.ca](mailto:hallman@wroughtiron.on.ca)



*Looking for Home Decor [furniture and such]  
Check out our website:*

***[www.wroughtiron.on.ca](http://www.wroughtiron.on.ca)***